



# Scientific Advisory Services

*Scientific Due Diligence and Project Management*

**DAXTACHEM SAM** is a company of the Frattale Group holding company based in Lucerne, Switzerland.

With **more than 10 years of experience** in this sector throughout Europe, thanks to the work of some 40 specialists in the various Frattale Group companies, **DAXTACHEM** is able to assist you in your investment decisions in the **life sciences, biotechnology** and **chemical sectors**. Through neutral and independent expertise, including the management of industrial processes, we will be able to advise you in order to **reduce the investment risk**.

# COMPANY'S MISSION

## SUSTAINABILITY

We strongly believe in the need to evolve towards industrial applications that maintain and increase the quality of life while **minimizing** or even neutralizing **environmental impacts**.

**MORE THAN 10 YEARS OF  
INTERNATIONAL EXPERIENCE**

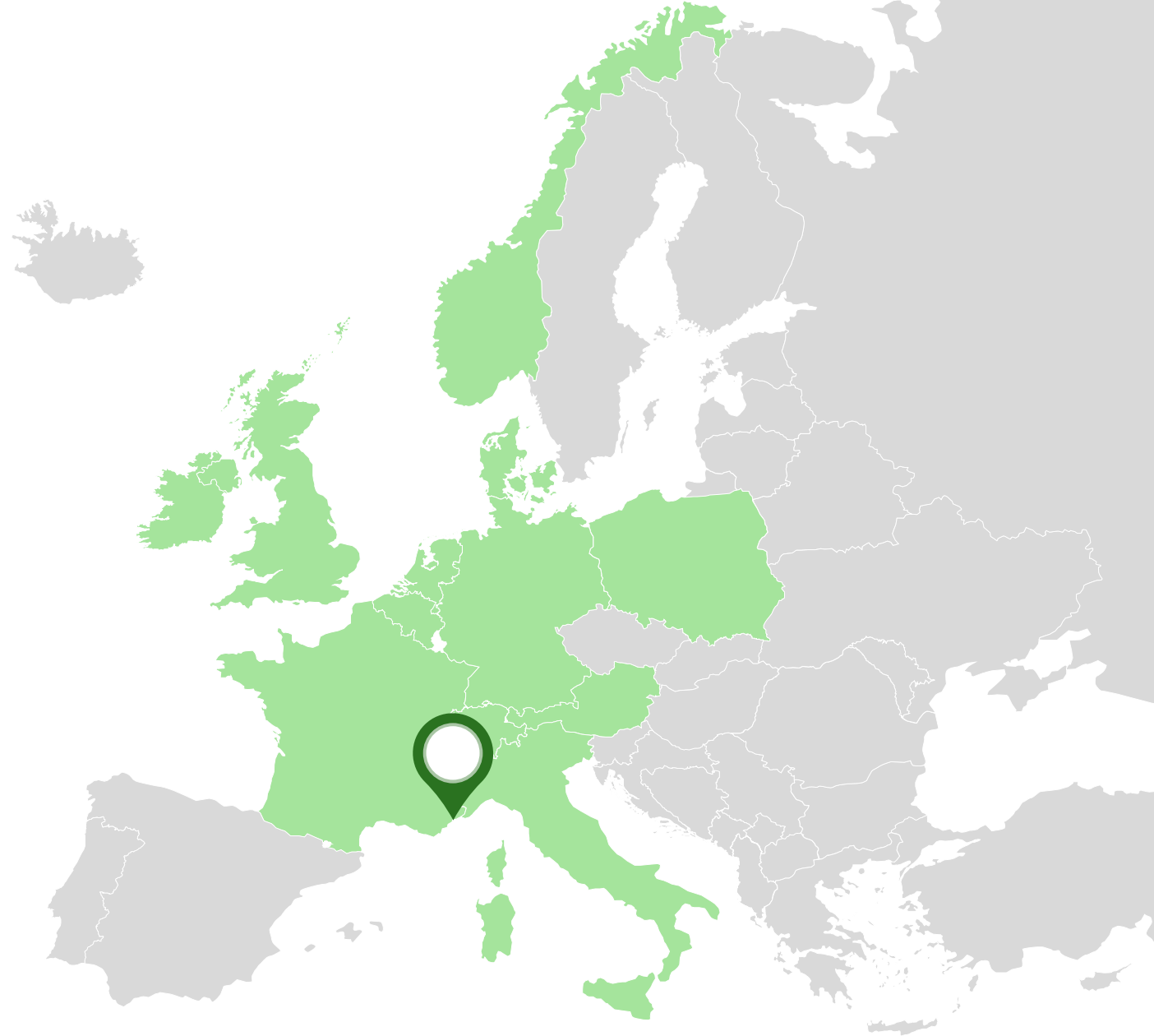



## SCIENTIFIC DUE DILIGENCE

- Scientific and theoretical evaluation of files.
- Independent product analysis.
- Conducting independent product evaluation and performance tests.
- Steering R&D projects as guarantor of investors' interests.
- Management of scale-up and industrialization projects.
- Networking and partner search.
- Independent expertise, including academic expertise.

The logo for Unil, featuring the word "Unil" in a blue, cursive script font.

**UNIL** | Université de Lausanne



Haute école d'ingénierie et d'architecture Fribourg  
Hochschule für Technik und Architektur Freiburg

## SCIENTIFIC DUE DILIGENCE: WHAT IS THE OBJECTIVE?

- Reduce investment risks.
- Scientific monitoring and steering as a representative of the investors.
- Setting up and monitoring of projects.
- Scientific investigation and reverse engineering.
- Intermediation.
- Intellectual protection.



## SCIENTIFIC DUE DILIGENCE: LIFE SCIENCES & CHEMISTRY

<p><b>Environmental biotechnology</b></p> <p><b>Green Chemistry</b></p> <p><b>Revalorization and recycling</b></p> <p><b>Biomaterials</b></p> <p><b>Food-tech</b></p>	<ul style="list-style-type: none"><li>✓ Evaluation of files at all levels of development</li><li>✓ Project management at all levels of development</li><li>✓ Evaluations and analyses</li><li>✓ Industrialization</li><li>✓ Reverse engineering</li><li>✓ Intellectual Property</li></ul>
---	---

## SCIENTIFIC DUE DILIGENCE: LIFE SCIENCES & CHEMISTRY

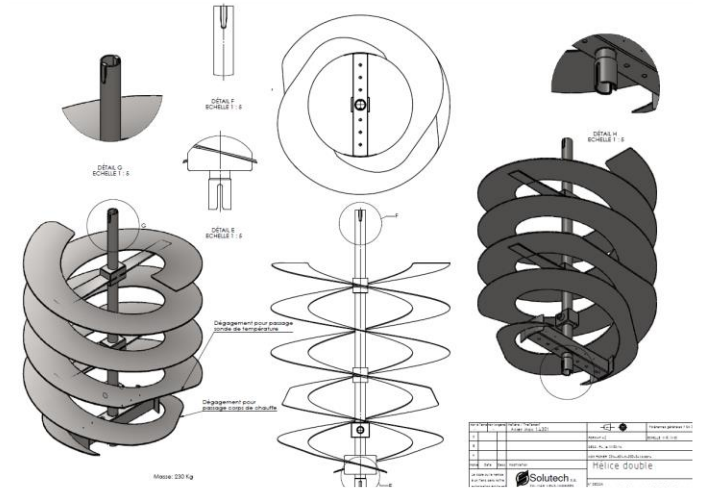
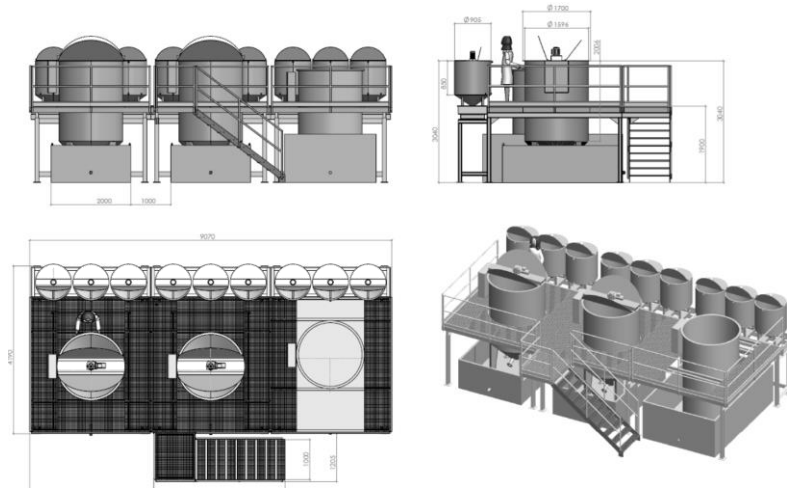

<p>Pharmaceutical MedTech</p>	<ul style="list-style-type: none"><li>✓ Evaluation of basic and <i>in vitro</i> research files</li><li>✓ Steering of collaborative projects between academia and industry at the fundamental and pre-clinical levels</li><li>✓ Scale-up to pre-industrial status</li><li>✓ Reverse engineering</li></ul>
-----------------------------------	--

## PROJECT MANAGEMENT: FROM THE LABORATORY TO THE INDUSTRY











## CONFIDENTIAL

Agent & Reference	Domain	Our role
<p>Michele JERMINI, CEO Alfa Chemicals Switzerland <a href="mailto:mjermi@alfachemicalsint.com">mjermi@alfachemicalsint.com</a></p> 	<p><b>Pharmaceutical</b> <b>Pharmaceutical biotechnology</b></p>	<p>Steering of public-private R&amp;D projects, Freedom-to-operate.</p>
<p>Gilbert LIGNER, CEO Vyridis <a href="mailto:gilbert.ligner@vyridis.com">gilbert.ligner@vyridis.com</a></p> 	<p><b>Food-tech</b> <b>Food supplements</b></p>	<p>Scientific evaluation, Laboratory tests.</p>
<p>Silvia SEBASTIANI, Head Medical Affairs <a href="mailto:silvia.sebastiani@helsinn.com">silvia.sebastiani@helsinn.com</a></p> 	<p><b>Pharmaceutical</b> <b>Medtech</b></p>	<p>Steering of public-private R&amp;D projects, Freedom-to-operate, Development management of medtech equipment.</p>





## CONFIDENTIAL

Agent & Reference	Domain	Our role
<p>Pierre KLADNY, Managing partner <a href="mailto:pierre.kladny@valleyroadcapital.com">pierre.kladny@valleyroadcapital.com</a></p> 	<p><b>Investment in environmental biotechnology and the circular economy</b></p>	<p>R&amp;D project management, Freedom-to-operate, Quality control, Industrial scale-up.</p>
<p>Paolo BASSANINI, COO <a href="mailto:paolo.bassanini@bioma.com">paolo.bassanini@bioma.com</a></p> 	<p><b>Agrochemistry</b> <b>Environmental biotechnology</b></p>	<p>Scientific evaluation, Evaluation of new products.</p>
<p>Pierdomenico BIASI, R&amp;D Department Head <a href="mailto:p.biasi@casale.ch">p.biasi@casale.ch</a></p> 	<p><b>Agrochemistry</b></p>	<p>R&amp;D project management, Freedom-to-operate, Development steering, Scientific support for the group's strategy.</p>

## CONFIDENTIAL

Agent & Reference	Domain	Our role
<p>Staffan AHLGREN, CEO Tyre Recycling Solutions <a href="mailto:sah@trs-ch.com">sah@trs-ch.com</a></p> 	<p><b>Recycling</b></p> <p><b>Polymer upgrading</b></p>	<p>R&amp;D project management, Scale-up management, IP verification, Coordination of patent drafting.</p>
<p>Dimitrios TERZIS, CEO Medusoil <a href="mailto:dimitrios.terzis@medusoil.com">dimitrios.terzis@medusoil.com</a></p> 	<p><b>Environmental biotechnology</b></p> <p><b>Bio-consolidation of soils</b></p>	<p>Scientific development, Industrialization &amp; IP management.</p>
<p>Lucien GENOUD, CEO Levatura <a href="mailto:lucien@levatura.ch">lucien@levatura.ch</a></p> 	<p><b>Food-tech</b></p> <p><b>Biotechnology</b></p>	<p>Scientific evaluation, Industrialization management, Quality control.</p>

## CONFIDENTIAL

Agent & Reference	Domain	Our role
Pierre BORDRY, <b>MW Partners Holding</b>  Managing Partner +41 (0)79 797 49 59	<b>Pharmaceutical</b>	Investment evaluation in the medical / neurology field, Support for the development of the medical network.
Mustafa OKUMUS, <b>IHS Group</b>  CEO IHS Group <a href="mailto:mail@ihsgroup.ch">mail@ihsgroup.ch</a>	<b>Environmental biotechnology</b>	Evaluation of investments in the field of bioremediation.
	<b>Pharmaceutical</b>	Evaluation of investments, Management of a development project.
Virginie VERDON, <b>GREEN BROTHERS</b>  Managing Partner <a href="mailto:virginie.verdon@bstmc.com">virginie.verdon@bstmc.com</a>	<b>Consumer goods</b>	Scientific expertise.